

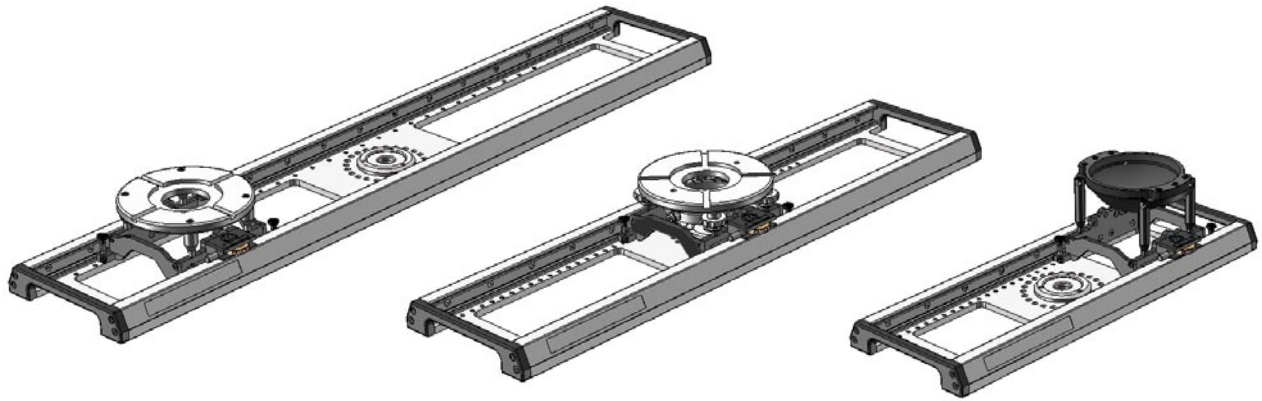

KEY GRIP SYSTEMS
Development

CAMERA SUPPORTS

Sliders



Slider 50"

Slider 40"

Slider 25"

> **Our sliders** are available in 3 different lengths : 25" ,40" & 50".
Each slider can be fit within seconds with a choice of three different sliding bases
Ultra – flat leveling Mitchell base, Straight Mitchell base and Arri 150 bowl base.

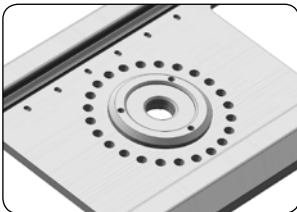

Sliders fits directly to PW III and PW IV noses using the original Chapman pin lock.

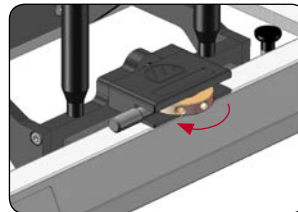

Each sliding base has smooth but strong precision break.

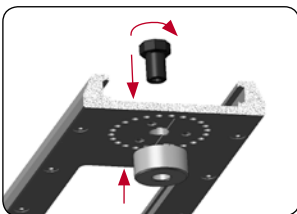

Sliders fit with adapter (FSL002) to Mitchell base.

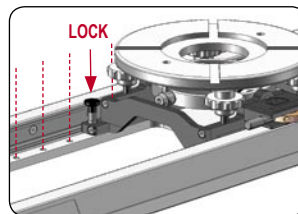

Sliding bases may be locked precisely in position with 2 locking pins.

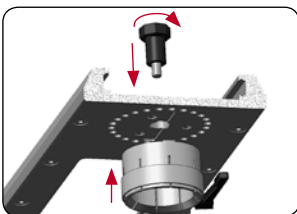

Sliders fit with adapter (FSL001) to European Coupling.

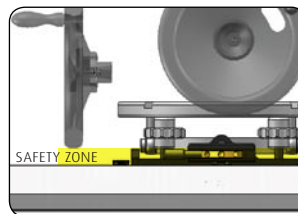

The Ultra-flat leveling Mitchell base still allows gear head operating.



KEY GRIP SYSTEMS
Development

CAMERA SUPPORTS

Sliders

Sliders

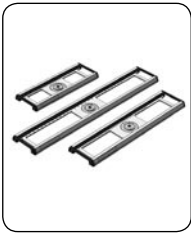

ref.	width
FSL1280	50"
FSL0960	38"
FSL0640	25"

Leveling Mitchell sliding base



ref.
FSLC300B

Straight Mitchell sliding base



ref.
FSLC300

Arri 150 bowl sliding base



ref.
FSLC120

European coupling fitting



ref.
FSL001

Michell fitting

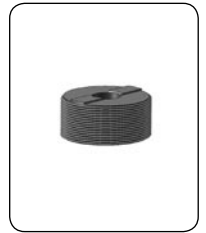

ref.
FSL002

